

LOC	DIST	REVISIONS					
E	B	P	LTR	DESCRIPTION	DATE	DWN	APVD
			BA	NEW RELEASE	25-MAR-10	MRS	St.P

FOR FURTHER INFORMATION SEE DATA SHEET FOR  
NTC SERIES-NEGATIVE TEMPERATURE COEFFICIENT CHIP THERMISTORS

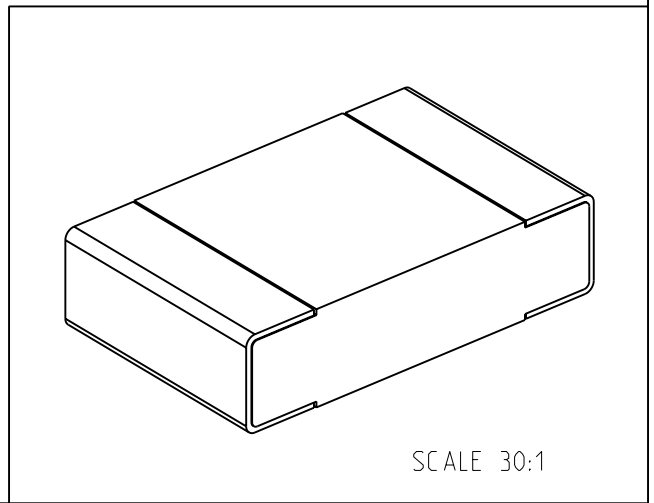

RoHS Compliant



2010

RELEASED FOR PUBLICATION

THIS DRAWING IS UNPUBLISHED.

BY TYCO ELECTRONICS CORPORATION. ALL RIGHTS RESERVED.

DIMENSIONS: mm	DWN MAHARUDRA	25-MAR-10	MATERIAL	-	FINISH	-
	CHK ALLAN.P	25-MAR-10	Tyco Electronics Corporation Dorcan, Swindon, SN3 5HH			
TOLERANCES UNLESS OTHERWISE SPECIFIED:	APVD STEPHEN.P	25-MAR-10				
0 PLC ±0.2	PRODUCT SPEC	-	NAME NEGATIVE TEMPERATURE COEFFICIENT CHIP THERMISTORS SERIES NTC0805			
1 PLC ±0.1	APPLICATION SPEC	-	SIZE	CAGE CODE	DRAWING NO	RESTRICTED TO
2 PLC ±-			A 4	00779	© = 1624366	-
3 PLC ±-			CUSTOMER DRAWING			
4 PLC ±-	WEIGHT	-	SCALE	40:1	SHEET	1 OF 1
ANGLES ±5°					REV	BA